

LEONI Part No.:
LEHC 004819 Rev.0

Construction

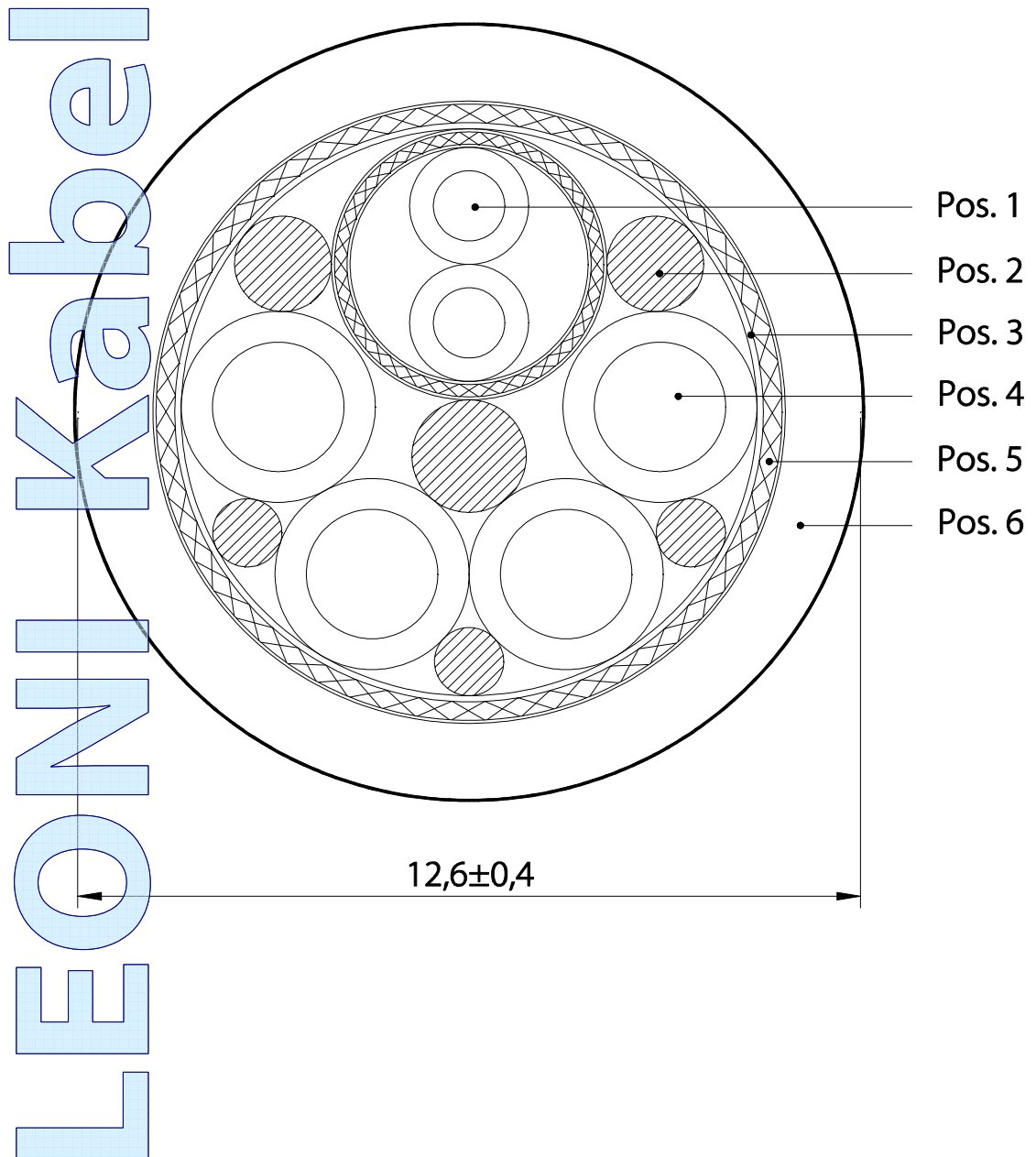

LEONI Part No.:
LEHC 004819 Rev.0

Cable description

Pos. 1 shielded pair 2x0,75 mm²



bare copper, single wire 0,15 mm
 in accordance to DIN EN 60228 cl. 6 / IEC 60228 cl. 6
 PP
 white and black,

braiding of tinned copper wires 0,10 mm
 optical covering min. 85 %

Pos. 2 filler

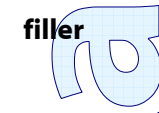

Pos. 3 tapings



Pos. 4 4 insulated wires 2,5 mm²

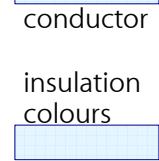

bare copper, single wire 0,15 mm
 in accordance to DIN EN 60228 cl. 6 / IEC 60228 cl. 6
 PP
 black wires with white marking U/L1/C/L+,
 V/L2, W/L3/D/L-, greenyellow

Pos. 5 shielding

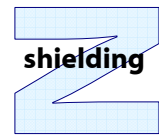

braiding of tinned copper wires 0,15 mm
 optical covering min. 85 %

Pos. 6 outer jacket

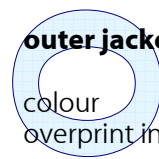

colour
 overprint in black with Inkjet

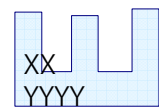

Polyurethan in accordance to DIN VDE 0282 Teil 10
 / HD22.10 S2
 orange mat following RAL 2003
 LEONI A FieldLink MC LEHC 004819 Rev.0
 [4x2,5+(2x0,75)] XX/YYYY
 E47543 c  us AWM STYLE 21223 I/II A/B 80°C 1000V FT-1
 production week
 production year
12,6 ± 0,4 mm



outer diameter

LEONI Part No.:
LEHC 004819 Rev.0

Electrical properties

operating voltage	Pos. 4 Pos. 4 according to 	U ₀ /U max. 1000 V max. 24 V
test voltage	Pos. 1 Pos. 1 according to  Pos. 4 conductor/conductor Pos. 4 conductor/shield Pos. 1 conductor/conductor Pos. 1 conductor/shield	max. 1000 V 4,0 kV 50Hz AC 4,0 kV 50Hz AC 4,0 kV 50Hz AC 4,0 kV 50Hz AC
conductor resistance	Pos. 1 Pos. 4	max. 26,0 Ω/km at +20°C max. 7,98 Ω/km at +20°C

Mechanical properties

bending radius for fixed installation	min. 5 x outside diameter
for drag chain installation	min. 7,5 outside diameter
acceleration	max. 50 m/s ²
traversing speed	max. 300 m/min
bendings in drag chains	min. 10.000.000
torque at a length of 1000 mm	max. ± 30 degree
horizontal length of the cable	max. 50 m
total weight	nom. 258 kg/km

Thermal properties

treatment and installation	-20°C bis +60°C
transport and stocking	-50°C bis +80°C
operating for fixed installation	-50°C bis +80°C
for drag chain installation	-20°C bis +60°C
short cut	max. +150°C (≤ 5 sec.)

LEONI Part No.:
LEHC 004819 Rev.0

Chemical properties

oil resistant in accordance to VDE 0282 part 10 / HD 22.10 S2 (test method to EN60811-2-1)
flame retardant in accordance to UL 1581 Vertical Wire Flame Test (VW-1)
flame retardant in accordance to CSA C22.2 Vertical Flame Test (FT-1)
flame retardant in accordance to IEC 60332-1-2
halogen free in accordance to EN 50267-2-2 / IEC 60754-2
free of silicon and FCKW



the cable corresponds to EU – directive 2002/95/EG (RoHS)

Standard

UL Subject 758; Style 21223 and CSA - C22.2 No. 210



E 47543

Cable is approved to UL Style 21223 80°C 1000V VW-1 and cUL AWM I/II A/B 80°C 1000V FT-1

FELTEN